

Miniature One-touch Fittings

One-touch Mini

Series KJ



Applicable Tubing: $\varnothing 3.2$, $\varnothing 4$, $\varnothing 6$
 Connection Thread: M3, M5, R 1/8

Guide 1

Guide 2

Chuck
 Suitable for use with nylon, soft nylon and urethane.
 Large retaining force.
 Has large retaining force.

Seal
 Can be used for a wide range of pressures from a low vacuum up to a pressure of 1.0 MPa
 The use of a special profile ensures sealing and reduces resistance when the tube is inserted.

Gasket

Release button (Light gray)
Light force for removal
 When the fitting is removed from the tubing, the chuck and collet are released, thus preventing them from biting into the tube to an unnecessary degree. Unique shape allows easy tube release.

Tube

Body (White)

O-ring

Stud
Effective when piping in a confined space.

- The body and the threaded portion can rotate (for positioning to some extent).
- Stud is electroless nickel plated.
- Standard with preapplied thread seal 1/8

PAT.PEND

- K
- M
- H
- D
- MS
- T
- VMG

Optimum piping in less space with 20% reduction of the outside diameter

Thread seal is standard.

Copper-free specifications (With electroless nickel plated.)

Possible to use in vacuum to -100 kPa



Applicable Tubing

| | |
|-----------------|---|
| Tubing material | Nylon, Soft nylon, Polyurethane |
| Tubing O.D. | $\varnothing 3.2$, $\varnothing 4$, $\varnothing 6$ |











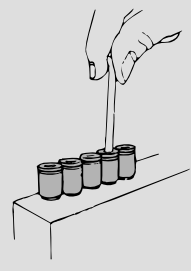



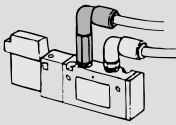



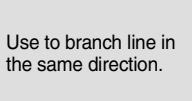

Specifications

| | | |
|-------------------------------|--|--|
| Fluid | Air/Water ^{Note} | |
| Maximum operating pressure | 1.0 MPa | |
| Operating vacuum pressure | -100 kPa | |
| Proof pressure | 3.0 MPa | |
| Ambient and fluid temperature | -5 to 60°C, Water: 0 to 40°C (No freezing) | |
| Thread | Mounting section | JIS B 0203 (Taper thread for piping) JIS B 0209, Class 2 (Metric coarse thread) |
| | Nut section | JIS B 0211 Class 2 (Metric fine thread) |
| Thread seal (Standard) | With thread seal | |
| Copper-free (Standard) | Brass parts are all electroless nickel plated. | |

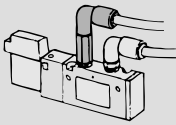
Note) Applicable for general industrial water. Please consult with SMC if using for other kinds of fluid. Also, the surge pressure must be under the maximum operating pressure.

Principal Parts Material

| | |
|-------------------------|-----------------------------------|
| Body | Stainless steel 303, C3604BD, PBT |
| Stud | C3604BD (Thread portion) |
| Chuck, Guide 2 | Stainless steel 304 |
| Release button, Guide 1 | POM |
| Seal, O-ring | NBR |
| Gasket | Stainless steel 304, NBR |

| Model | | | | | |
|--|---|------|---|---|--|
| Hex. socket head male connector KJS P. 4 |  | P. 4 | Internal hex. allows thread connection by using an allen wrench for confined spaces.  | Bulkhead union KJE P. 9 | Use to connect tubes through a panel.  |
| Male connector KJH P. 4 |  | P. 4 | Use to pipe in the same direction from female thread. Most general style. | Plug-in elbow KJL P. 5 | Use to change by 90° in a tube fetching direction from One-touch fittings.  |
| Female connector KJF P. 4 |  | P. 4 | Use to pipe from male thread such as pressure gauge. | Reducer elbow KJL P. 6 | Use to change by 90° in a tube fetching direction from One-touch fittings and to size down.  |
| Straight union KJH P. 4 |  | P. 4 | Use to connect tubes in the same direction. | Male branch tee KJT P. 6 | Use to branch line from female thread in both 90° directions.  |
| Different diameter straight KJH P. 5 |  | P. 5 | Use to connect different sized tubes. | Union tee KJT P. 7 | Use to connect tubes in both 90° directions.  |
| Male elbow KJL P. 5 |  | P. 5 | Use to pipe at right angles to female thread. Most general style. | Different diameter tee KJT P. 7 | Use to connect tubes with size down in both 90° directions.  |
| Union elbow KJL P. 5 |  | P. 5 | Use to connect tubes at right angles. | Male run tee KJY P. 7 | Use to branch line in the same direction from female thread and in 90° direction.  |
| | | | | | Extended male elbow KJW P. 6 |
| | | | | | Universal male elbow allows thread connection by using a socket wrench for confined spaces.  |
| | | | | | Union "Y" KJU P. 8 |
| | | | | | Use to branch line in the same direction.  |
| | | | | | Different dia. union "Y" KJU P. 8 |
| | | | | | Use to branch line with size down in the same direction.  |
| | | | | | Plug-in "Y" KJU P. 8 |
| | | | | | Use to branch line in the same direction from One-touch fittings.  |
| | | | | | Different diameter plug-in "Y" KJX P. 8 |
| | | | | | Use to branch line with size down in the same direction from One-touch fittings.  |
| | | | | | Branch "Y" KJU P. 9 |
| | | | | | Use to branch line in the same direction from female thread.  |
| | | | | | Plug-in reducer KJR P. 9 |
| | | | | | Use to change size of One-touch fittings.  |

Gasket/Seal for M5 thread

Part no.: M-5G2

Material: Stainless steel 304, NBR

- K□
- M□
- H□
- D□
- MS
- T□
- VMG

⚠ Precautions

Be sure to read before handling.
Refer to pages 15-18-3 to 15-18-4 for Safety Instructions and Common Precautions on the products mentioned in this catalog, and refer to pages 15-1-10 to 15-1-11 for Precautions on every series.

Interchangeability of Series KJ and KQ

⚠ Caution

- Do not use the plug-in KQ Series with the KJ Series, it will not hold.
- For combinations other than the plug-in KQs, they are interchangeable.

Installation and Removal of One-touch Mini Fittings

⚠ Caution

Installing of tube

- Cut the tube perpendicularly, using caution not to damage its surface. (Use tube cutter TK-1, 2 or 3. Do not cut the tube with cutting pliers, nippers, scissors, etc.)
- Grasp the tube, then slowly push it until it comes to a stop.
- Then, pull it back gently to make sure that it does not come out.

Removing of tube

(Use one hand for removal.)

- Hold the release button with the thumb and forefinger.
- Grasp the tube with the remaining three fingers and palm.
- Then, pull out the tube with three fingers and palm while pushing in the release button with the thumb and the forefinger.
- To reuse the released tube, cut off the damaged portion of the tube.

Different Diameter Straight: KJH



| Applicable tubing O.D. (mm) | | Model | Note) $\phi D1$ | Note) $\phi D2$ | L | M1 | M2 | Effective area (mm ²) | | Weight (g) |
|-----------------------------|-----|----------|-----------------|-----------------|------|------|------|-----------------------------------|----------|------------|
| (a) | (b) | | | | | | | Nylon | Urethane | |
| 3.2 | 4 | KJH23-04 | 8.4 | 9.3 | 26.3 | 12.7 | 12.7 | 3 | 2.5 | 1.6 |
| | 6 | KJH23-06 | | 11.6 | | | 27.2 | | | 13.5 |
| 4 | 6 | KJH04-06 | 9.3 | 11.6 | 27.2 | 12.7 | 13.5 | 4 | 4 | 2.2 |

Note) $\phi D1$, $\phi D2$: Max. diameter

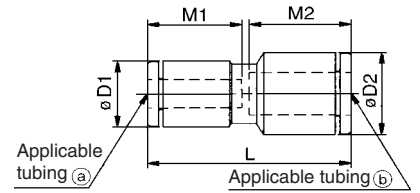

Male Elbow: KJL

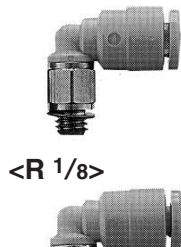

| <M3, M5> | Applicable tubing O.D. (mm) | Connection threads T | Model | H (width across flats) | Note) ϕD | L1 | L2 | A | M | Effective area (mm ²) | | Weight (g) | | | | | |
|----------|-------------------------------|-----------------------------------|-------|------------------------|----------------|------|------|------|-----|-----------------------------------|----------|------------|-------|-------|-----|-----|-----|
| | | | | | | | | | | Nylon | Urethane | | | | | | |
| 3.2 | M3 x 0.5 M5 x 0.8 R 1/8 | KJL23-M3 KJL23-M5 KJL23-01S | 7 | 8.4 | 15.3 | 12.5 | 14.1 | 12.7 | 0.8 | 0.8 | 2.1 | | | | | | |
| | | | | | | | | | | | | 13.2 | 14.3 | 2.6 | 2.2 | 2.5 | |
| | | | | | | | | | | | | 15.2 | 15.4* | 6.7 | | | |
| 4 | M3 x 0.5 M5 x 0.8 R 1/8 | KJL04-M3 KJL04-M5 KJL04-01S | 7 | 9.3 | 15.6 | 13 | 15.1 | 12.7 | 0.8 | 0.8 | 2.2 | | | | | | |
| | | | | | | | | | | | | 13.7 | 15.3 | 3.5 | 3.5 | 2.7 | |
| | | | | | | | | | | | | 15.7 | 16.4* | 6.8 | | | |
| 6 | M5 x 0.8 R 1/8 | KJL06-M5 KJL06-01S | 7 | 11.6 | 16.1 | 14.7 | 17.4 | 13.5 | 3.5 | 3.5 | 3.2 | | | | | | |
| | | | | | | | | | | | | 17.8 | 16.7 | 18.5* | 9 | 9 | 6.4 |

* Reference dimensions after R thread installation.
Note) ϕD : Max. diameter

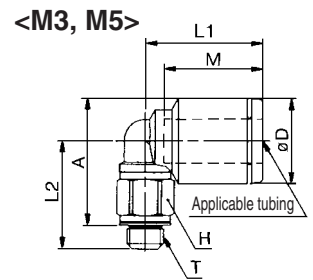

<R 1/8>

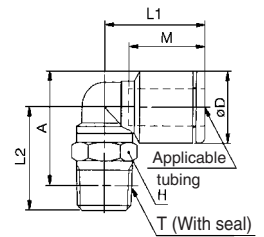

Union Elbow: KJL



| Applicable tubing O.D. (mm) | Model | Note) ϕD | L | Q | M | Effective area (mm ²) | | Weight (g) |
|-----------------------------|----------|----------------|------|-----|------|-----------------------------------|----------|------------|
| | | | | | | Nylon | Urethane | |
| 3.2 | KJL23-00 | 8.4 | 15 | 5.8 | 12.7 | 2.6 | 2.2 | 1.6 |
| 4 | KJL04-00 | 9.3 | 15.8 | 6.3 | 12.7 | 3.5 | 3.5 | 2 |
| 6 | KJL06-00 | 11.6 | 17.1 | 7.3 | 13.5 | 9 | 9 | 3.1 |

Note) ϕD : Max. diameter

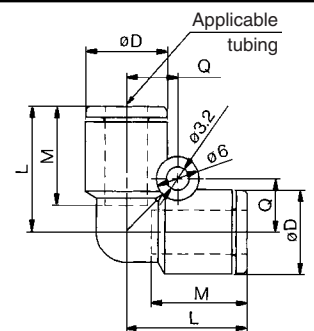

Plug-in Elbow: KJL

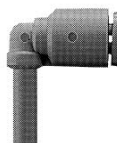

| Applicable tubing O.D. (mm) | Applicable fitting size ϕd | Model | Note) $\phi D1$ | $\phi D2$ | L1 | L2 | A | M | Effective area (mm ²) | | Weight (g) |
|-----------------------------|----------------------------------|----------|-----------------|-----------|------|------|------|------|-----------------------------------|----------|------------|
| | | | | | | | | | Nylon | Urethane | |
| 3.2 | 3.2 | KJL23-99 | 8.4 | 6 | 14.5 | 23.8 | 15.3 | 12.7 | 2.6 | 2.2 | 1 |
| 4 | 4 | KJL04-99 | 9.3 | 6 | 15.6 | 24.7 | 16.7 | 12.7 | 3.5 | 3.5 | 1.2 |
| 6 | 6 | KJL06-99 | 11.6 | 7 | 16.3 | 26.8 | 19.1 | 13.5 | 9 | 9 | 2 |

Note) $\phi D1$: Max. diameter

